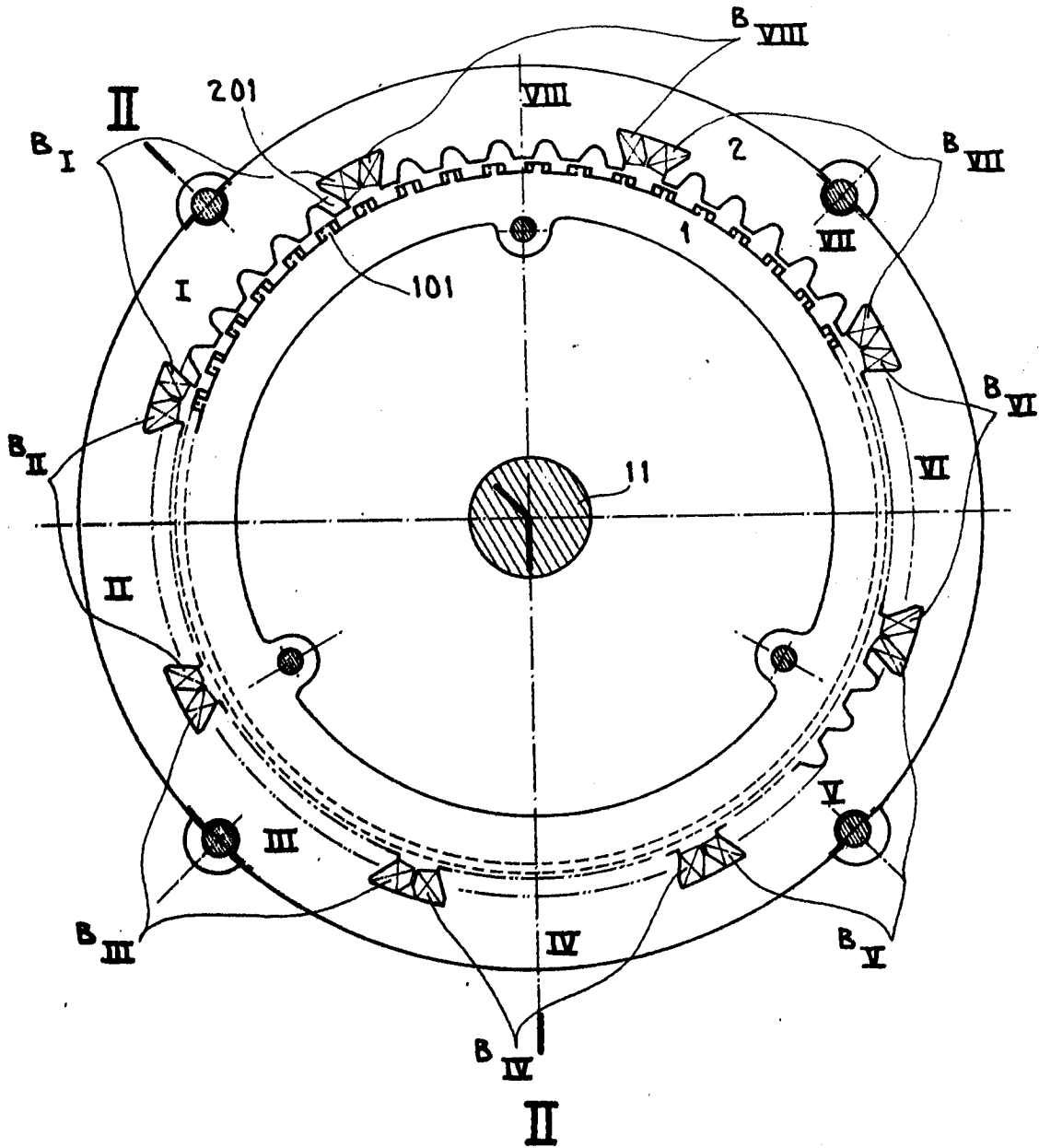
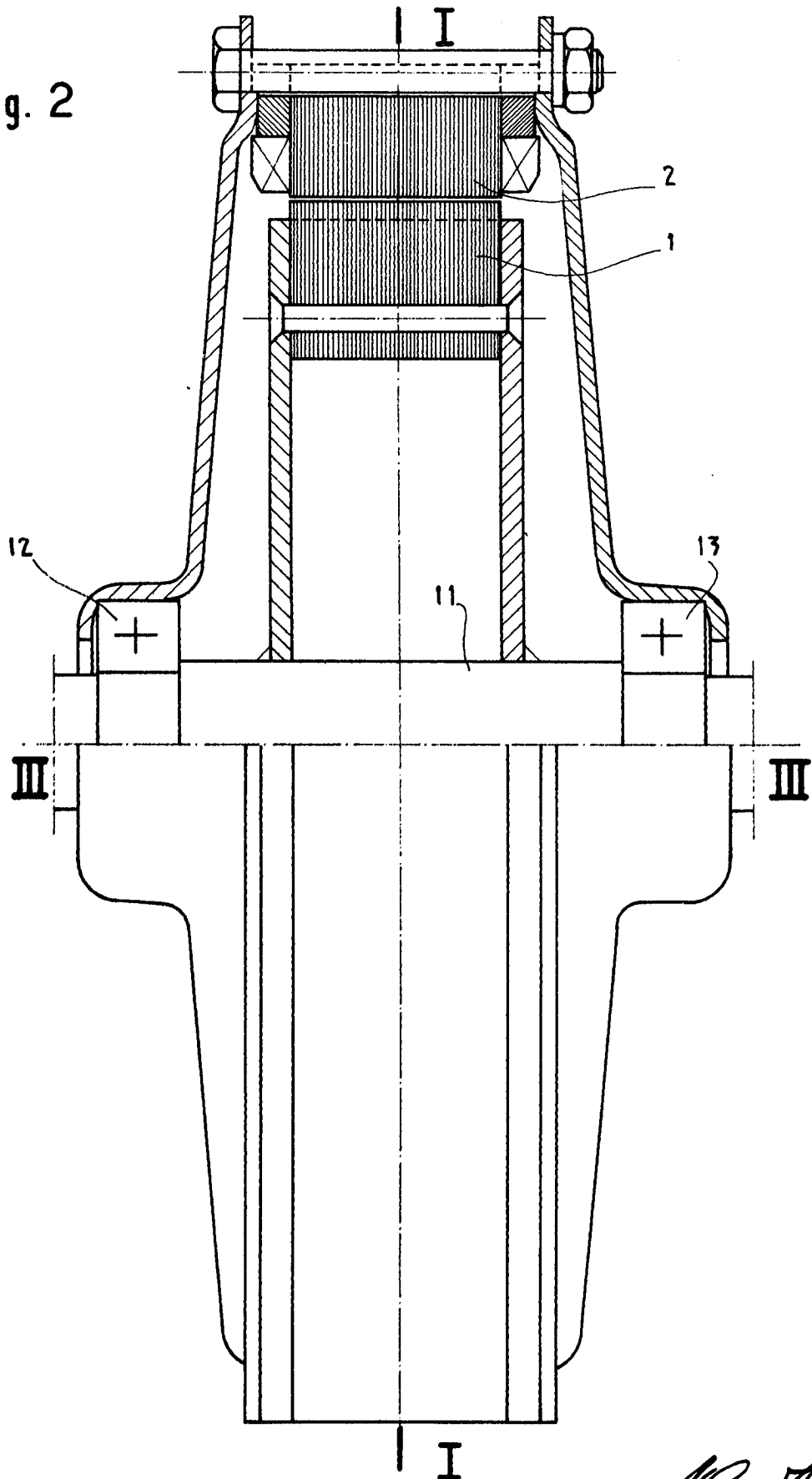

Fig. 1



*Maxim Eric Alder*

Fig. 2



*Marion Rice & Co.*

attorneys

Fig. 3

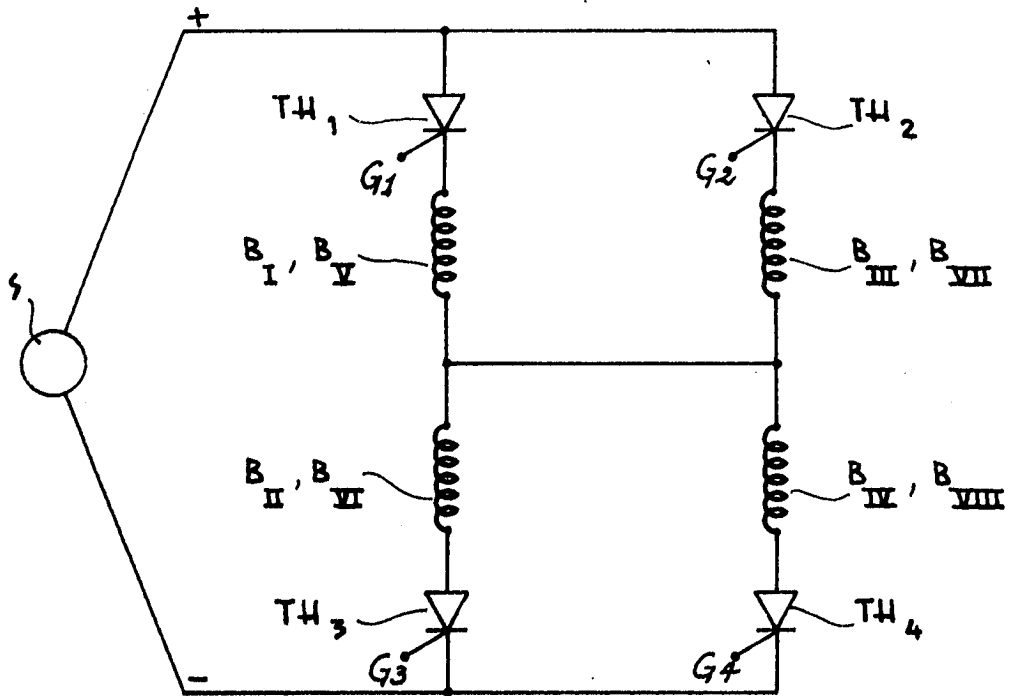

*Mason, Rice & Rice*

attorneys

— Fig. 4

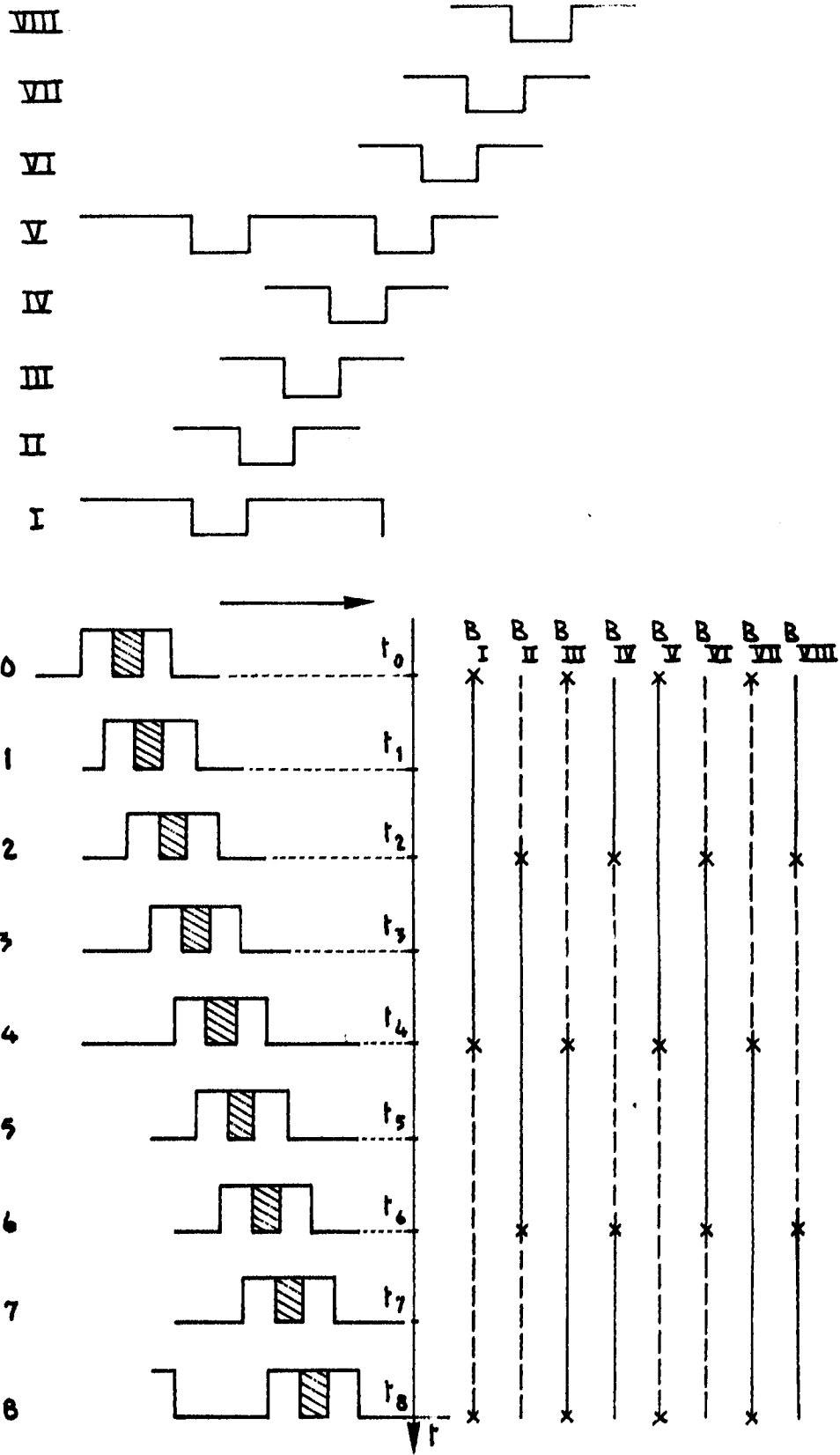

*Maxim, Reic & Reic*

attorneys

Fig. 5

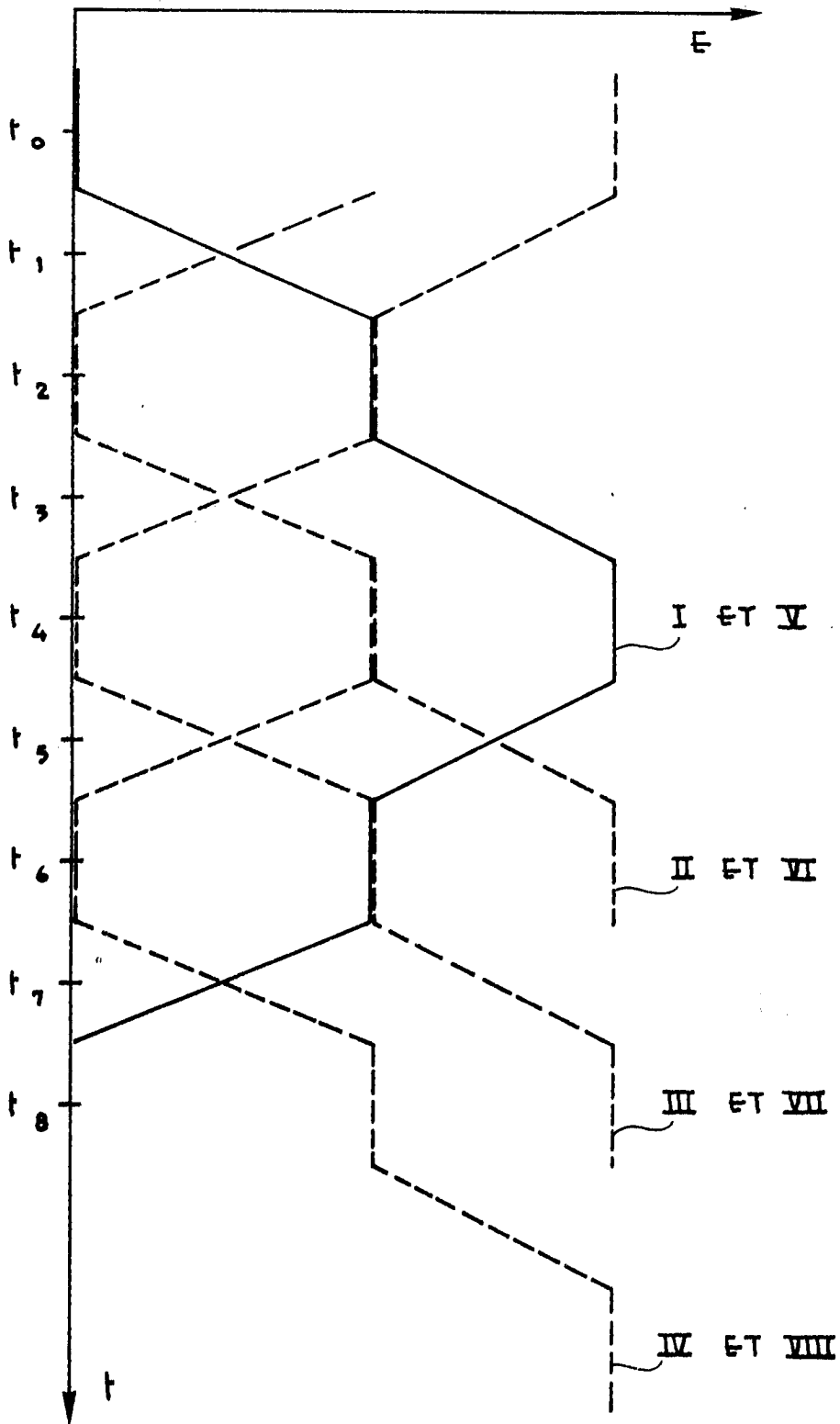

*Maxon, Rice & Rice*

attorneys

Fig. 6

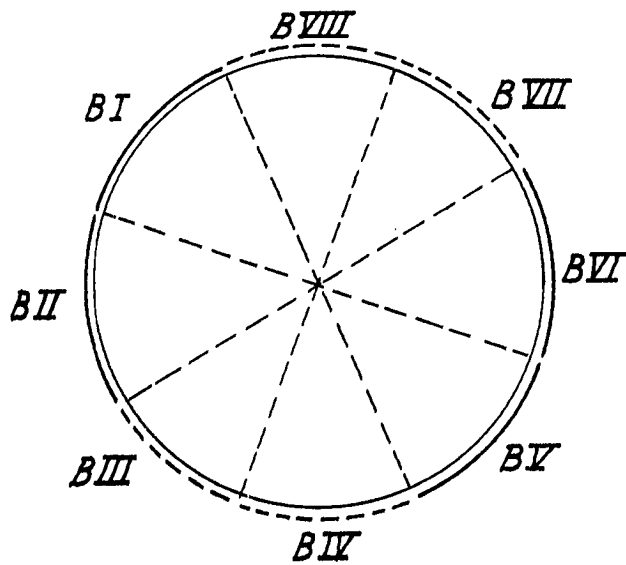
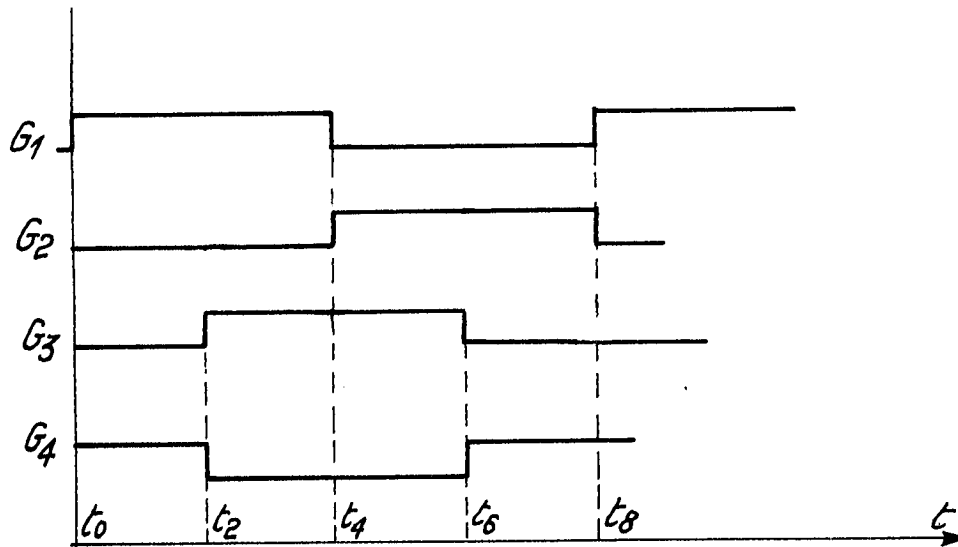
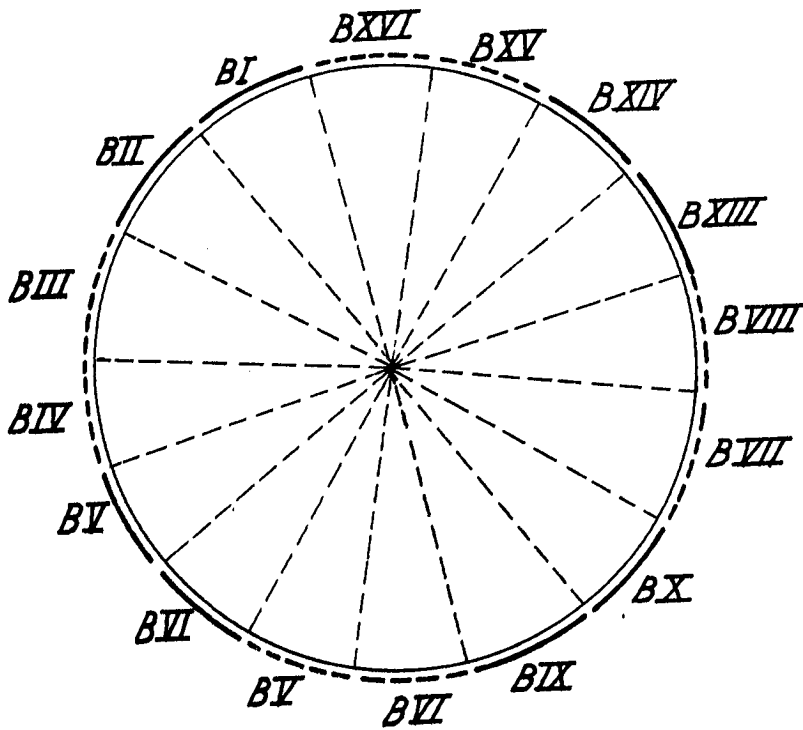

Fig. 7

*Maxon, Rice & Rice*

attorneys

Fig. 8



*Marion, Rice & Rice*

attorneys